

column radii.) Microscopic investigation of the soldered contacts show them to be unchanged by thermal pinching; the extrusions clearly come from the InSb crystals, not the solder.

DISCUSSION

The appearance of extrusions from the crystals at their surfaces immediately adjacent to the current-carrying contacts at a definite time after the cessation of thermal pinching suggests the following mechanism. As the pinch column melts the lattice within its well-defined path (see I for details) the melt accumulates vacancies. When the power is turned off, solidification begins at the outer shell of the pinch column and the solid phase moves radially toward the axis. Since the

solidification takes place rapidly, within a few tens of μsec , some vacancies are trapped in the solid phase. The expansion caused by freezing at the outer shell then forces some of the remaining molten crystal out the ends of the pinch channel.

The preferential appearance of the "squirted" cones at the positive current contact is probably the result of higher temperatures in its region than at the negative contact, but why such a consistent temperature gradient should exist is not understood.

ACKNOWLEDGMENTS

The authors are grateful to Professor R. E. Burgess for calling Ref. 2 to their attention and to M. F. Berg and R. W. Boice for technical aid.

Viscosity of Liquid He II

J. T. TOUGH,* W. D. MCCORMICK, AND J. G. DASH

University of Washington, Seattle, Washington

(Received 8 August 1963)

The viscosity of liquid He^4 has been measured between 1.10°K and the lambda point. A new type of viscometer was used, based on the damping of the transverse vibrations of a fine wire stretched between two rigid supports. The simplicity of the hydrodynamic problem and the low nuisance damping of the wire make this technique particularly appropriate for the measurement of small viscosities. The smoothed data are presented and found to be in good agreement with the latest rotating cylinder viscometer results. In different experimental runs the vibration frequency was varied by a factor of seven and the wire diameter by a factor of three. There was no evidence of systematic trend due to mean free-path effects or geometrical corrections.

I. INTRODUCTION

THE viscosity of liquid-helium II has been measured by many different investigators, using various experimental techniques. In recent years, the methods have included mass flow in fine capillaries,¹⁻³ heat transport in capillaries,⁴ oscillating disks,⁵⁻¹⁰ torsional vibrations of cylinders,¹¹⁻¹³ attenuation of sound,¹⁴ and

constant angular velocity viscometers.^{15,16} The results vary widely, especially in the temperature range below 1.6°K , and there are few examples of close correspondence between the sets of data obtained with different techniques. Each method has its peculiar difficulties and inaccuracies. One major problem in any hydrodynamic measurement is the correction for nonideality of the measuring device; end and edge corrections often prove to be large and difficult to estimate. Oscillating disk experiments also require careful measurement of the natural decay time of the system. This paper reports on measurements obtained with a new type of viscometer,¹⁷ which is based upon the attenuation of transverse vibrations of a taut wire. This technique eliminates many of the difficulties mentioned above and gives viscosity measurements of high precision and reliability. These results agree very well with recent measurements obtained by a rotating cylinder viscometer.^{15,16}

* National Science Foundation Predoctoral Fellow.

¹ R. Bowers and K. Mendelssohn, Proc. Roy. Soc. (London) **A204**, 366 (1950).

² F. A. Staas, K. W. Taconis, and W. M. van Alphen, Physica **27**, 893 (1961).

³ H. H. Tjerkstra, Physica **18**, 853 (1952).

⁴ D. F. Brewer and D. O. Edwards, Proc. Roy. Soc. (London) **A251**, 247 (1959).

⁵ E. L. Andronikashvili, Zh. Eksperim. i Teor. Fiz. **18**, 429 (1949).

⁶ E. L. Andronikashvili, J. Phys. (USSR) **10**, 201 (1946).

⁷ E. L. Andronikashvili, Zh. Eksperim. i Teor. Fiz. **18**, 424 (1948).

⁸ A. C. Hollis-Hallett, Proc. Roy. Soc. (London) **A210**, 404 (1951).

⁹ J. G. Dash and R. D. Taylor, Phys. Rev. **105**, 7 (1957).

¹⁰ C. B. Benson and A. C. Hollis-Hallett, Can. J. Phys. **38**, 1376 (1960).

¹¹ B. Welber, Phys. Rev. **119**, 1816 (1960).

¹² K. M. Eisele and A. C. Hollis-Hallett, Can. J. Phys. **36**, 25 (1957).

¹³ R. W. Webeler, Bull. Am. Phys. Soc. **8**, 373 (1963).

¹⁴ K. N. Zinoveva, Zh. Eksperim. i Teor. Fiz. **31**, 31 (1956), [translation: Soviet Phys.—JETP **4**, 36 (1957)].

¹⁵ W. J. Heikkila and A. C. Hollis-Hallett, Can. J. Phys. **33**, 420 (1955).

¹⁶ A. D. B. Woods and A. C. Hollis-Hallett, Can. J. Phys. **41**, 4 (1963).

¹⁷ J. T. Tough, W. D. McCormick, and J. G. Dash, Rev. Sci. Instr. (to be published).

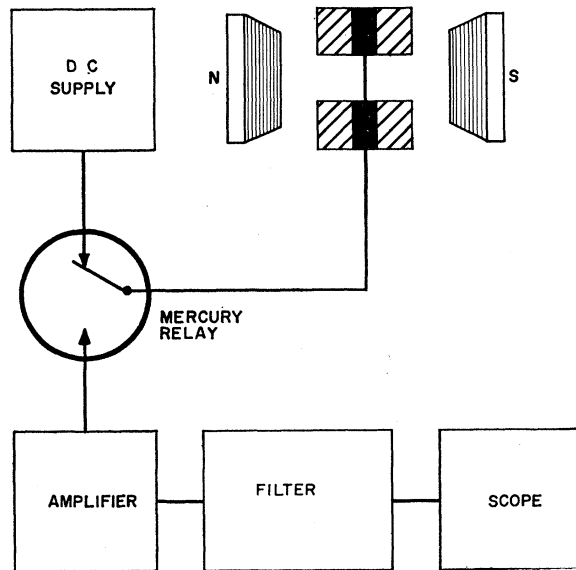

FIG. 1. Block diagram of experimental apparatus.

II. THEORY AND DESCRIPTION

A block diagram of the apparatus is shown in Fig. 1. The stretched wire is situated in a transverse magnetic field, and is deflected when a direct current is passed through it. When the wire has attained a steady deflection, the current is switched off and the wire is connected to the input of a low noise amplifier. The alternating voltage induced by the decaying vibrations of the wire across the magnetic field are amplified, displayed on an oscilloscope and photographed. A similar apparatus was used by Vinen¹⁸ to measure the circulation in rotating liquid-helium II. A second exposure is made at a higher sweep rate to measure the frequency. The decay constant τ is then obtained from the photograph by plotting the output signal amplitude on semilog paper, fitting a straight line to the points, and calculating the slope. A typical photograph and semi-log plot are shown in Fig. 2.

The theory and construction of the viscometer are treated elsewhere¹⁷ and will be reviewed only briefly here. A solution due to Stokes¹⁹ for the damping of an infinite cylinder in a viscous medium can be applied to the vibrating wire. The result is that a wire of radius a and mass-per-unit length μ , which undergoes transverse vibrations at a frequency ω in a fluid of density ρ_n and viscosity η , damps with a decay time given by

$$\tau = 2(\mu + \mu') / \pi \rho_n a^2 \omega k'(m). \quad (1)$$

Here $2m$ is the ratio of the wire radius to the viscous penetration depth λ

$$m = a / (2\lambda) \quad \lambda = (\eta / \omega \rho_n)^{1/2}. \quad (2)$$

¹⁸ W. F. Vinen, Proc. Roy. Soc. (London) **A260**, 218 (1961).

¹⁹ G. G. Stokes, *Mathematical and Physical Papers* (Cambridge University Press, London, 1922), Vol. 3, p. 38.

The solution given by Eq. (1) is valid under the condition

$$m > 0.5. \quad (3)$$

The meaning of this condition, as seen from Eq. (2) is that the penetration depth not be larger than the radius of the wire. The total hydrodynamic mass of the wire in the fluid is given by μ' , where

$$\mu' = \pi \rho_n a^2 k(m) \quad (4)$$

and the functions $k(m)$ and $k'(m)$ given by Stokes are plotted in Fig. 3. For large values of m the approximation

$$k'(m) = \sqrt{2}/m + \frac{1}{2}m^{-2} \quad (5)$$

can be used. Assuming that the nuisance damping and added hydrodynamic mass of the wire can be neglected, the viscosity is then given by

$$\eta = a^2 \omega \rho_n / 4 [m(k')]^2, \quad (6)$$

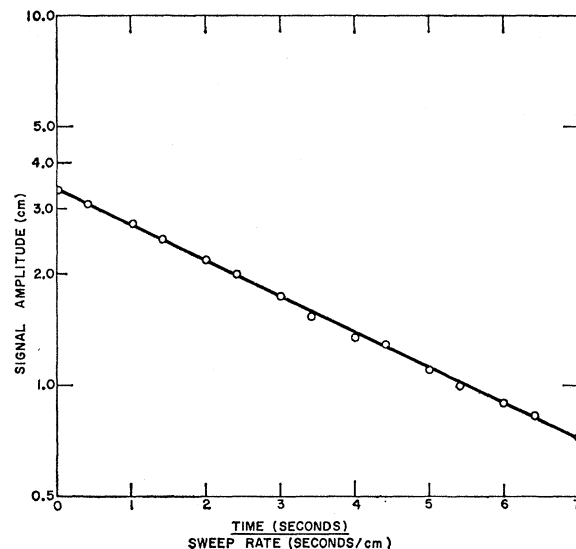
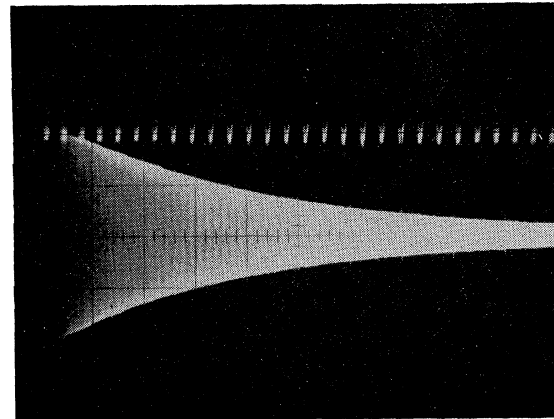
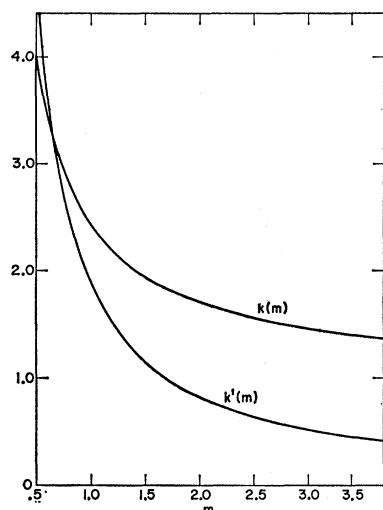

FIG. 2. (a) A typical oscilloscope photograph showing the exponential decay of the wire and the frequency. (b) The amplitudes of the exponential decay photograph [Fig. 2(a)] on a semilog plot.

FIG. 3. The function $k'(m)$ used in computing the viscosity, and the function $k(m)$ used in computing the added hydrodynamic effective mass of the wire.



where

$$k' = 2\mu/\pi\rho_n a^2 \omega \tau, \quad (7)$$

and we have used either the approximation given in Eq. (5) or a large graph plotted from the table given by Stokes to obtain $m(k')$.

The wires used in the majority of the measurements were 5.0-cm lengths of 0.001-in. hard-drawn tungsten. The tension could be adjusted to give frequencies from about 300 cps to 4.0 kc/sec, and the current determining the initial deflection of the wire was such that a maximum displacement of about four diameters at 2.0 kc/sec was produced. High enough frequencies were obtainable to satisfy the condition on m in Eq. (3).

Figure 4 shows the way in which the wire was mounted. We found that the signal from the vibrating wire was sometimes modulated by a slow change of the angle between the magnetic field and the plane of vibration of the wire, and that this effect could be removed by slightly twisting the wire. The wire control mechanism (5, 6, 7) can independently adjust the tension and twist in the wire.

The vapor pressure of the helium was measured by mercury and oil manometers which communicated with the liquid through the tube (10) of Fig. 4. Temperatures are based on the 1958 vapor pressure scale of van Dijk *et al.*²⁰ The manometers were used to calibrate a resistance thermometer of standard design. An electronic temperature regulator was also used.

III. RESULTS

A total of 140 data points were taken on six different runs. Five of the runs were made with five different 0.001-in. wires, and one with a 0.003-in. wire. Frequencies ranging from 475 cps to 3.34 kc/sec were used. The experimental decay constants for the 0.003-in. wire are shown in curve A of Fig. 6. A smooth curve was

fitted to the viscosity values with a mean deviation of 2.1%, and is shown in Fig. 5. The smoothed values are given in Table I along with the values of normal fluid density from which they were computed.

The measurements reported here are subject to errors from several sources. Systematic errors may arise from approximations involved in the solution to the hydrodynamic equations, from the treatment of nuisance damping, or from the geometry, insofar as the actual system differs from that treated theoretically. Finally, scatter results from several sources of random error.

Since the theory used in these calculations assumes that the fluid is continuous, one expects to measure a viscosity smaller than the calculated value when the mean free path of the momentum carriers becomes of the order of the dimensions of the apparatus (see, for example, the capillary measurements of Brewer and Edwards⁴). At 1.10°K the phonon free path calculated from the theory of Landau and Khalatnikov²¹ is within an order of magnitude of the dimensions of our apparatus. However, since no dependence on wire size

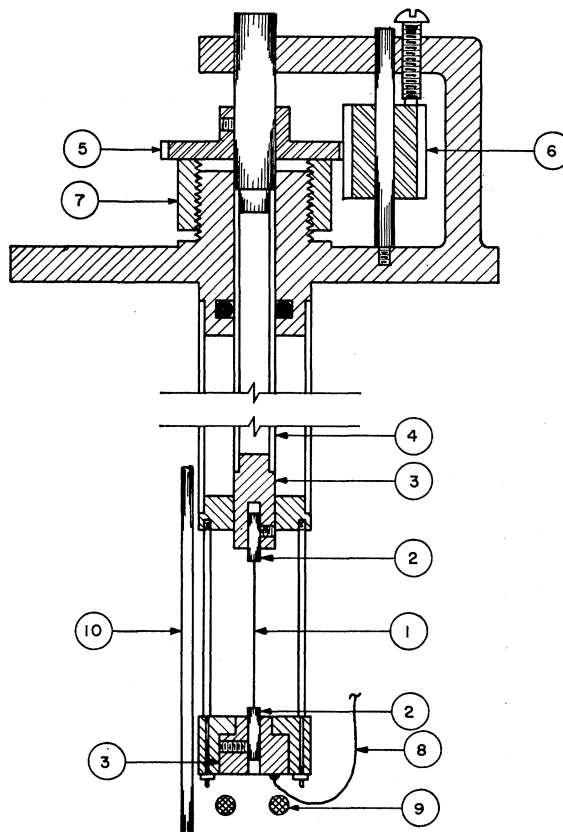

FIG. 4. Details of the wire holding apparatus. (1) Tungsten wire; (2) ends soldered to wire; (3) chucks; (4) control rod; (5) control gear; (6) control gear; (7) tension control; (8) signal lead; (9) resistors for thermometry.

²⁰ H. van Dijk, M. Durieux, J. R. Clement, and J. K. Logan, Natl. Bur. Std. (U. S.), Monograph 10 (1960).

²¹ L. D. Landau and I. M. Khalatnikov, Zh. Eksperim. i Teor. Fiz. 19, 637 (1949).

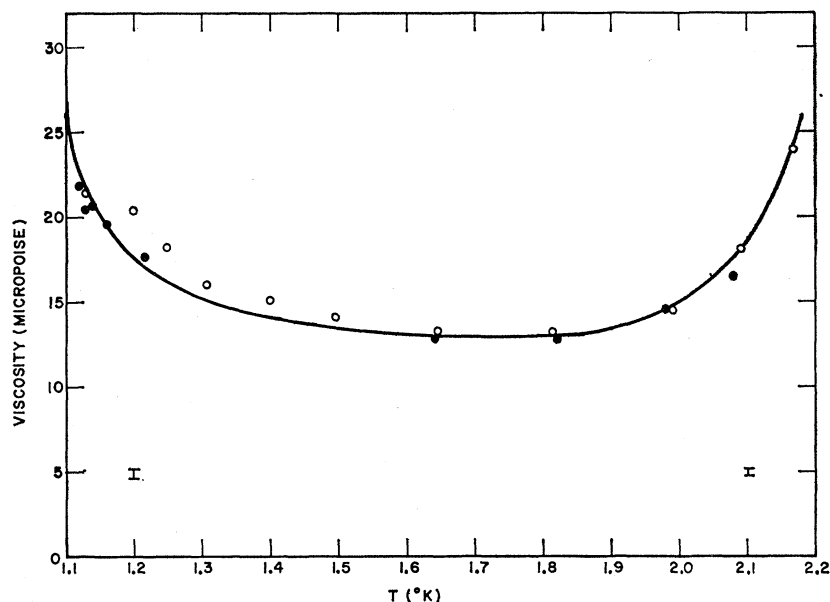

FIG. 5. Smoothed viscosity values shown as a function of temperature. Open circle, Heikkila and Hallett; solid circle, Woods and Hallett; solid line, vibrating wire. Errors for vibrating wire data are shown in the lower portion of the figure.

was observed, this effect could not have caused any systematic error. One might also measure too small a viscosity if the penetration depth λ approached the value of the mean free path. Viscosity measurements made at 1.245 and 1.128°K for which the ratio of penetration depth to mean free path was varied from 11 to 2.2 showed no variations other than normal scatter. Final quoted viscosities were computed from data corresponding to experimental conditions well within this explored range. The smallest value of this ratio, which occurred at 1.10°K, was 2.4.

The calculation of the viscosity from the decay constant involves the normal fluid density. Our density values were computed from smoothed second sound

velocities taken from the references in Atkins,²² and the latest Leiden thermal data.²³ They are given in Table I along with the smoothed viscosity values.

Instrumental error may be caused by the influence of the Dewar walls or mechanical supporting members on the damping of the wire, by the nuisance damping of the system, or by imperfections in the wire. One possible mechanism which could give rise to the observed modulation of the exponential decay of the wire is a small deviation from circularity of the wire's cross section. Five different 0.001-in. wires were used to obtain this data, and no systematic differences were observed. One of the wires was tested for cylindrical symmetry by vibrating it in different directions; we saw no systematic change in frequency or decay constant.

The calculation of viscosity from Eqs. (6) and (7) neglects nuisance damping entirely. At frequencies of about 2.0 kc/sec the nuisance damping of the 0.001-in. wire produced a decay constant of 22.2 sec, while the 0.003-in. wire gave a value of 62.3 sec, or a system "Q" of greater than 10^5 . When the experimental decay times are long, the effect of neglecting the nuisance damping is to give systematically high calculated viscosities. Since the measured decay times increase for decreasing temperatures, the error becomes larger at lower temperatures. For the decay times measured, the maximum possible error amounts to 2% at 1.22°K and 4% at 1.10°K. For temperatures greater than 1.4°K, the error is less than 1%. One of the advantages of the present apparatus is that the nuisance damping is extremely small, and does not need to be measured with great accuracy.

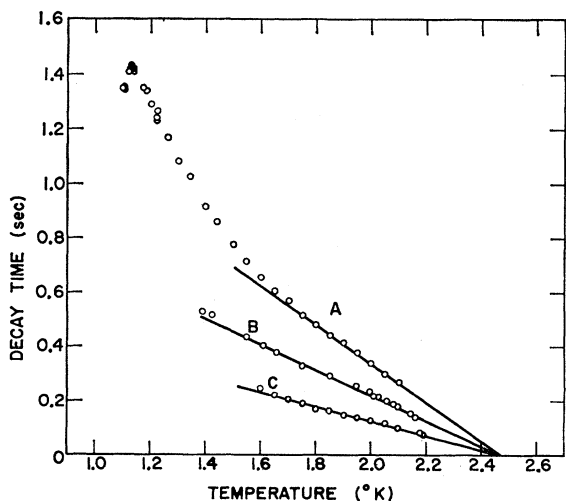

FIG. 6. Experimental decay times plotted against temperature. (A) Data from 0.003-in. wire at 1.97 kc/sec. (B) Data from 0.001-in. wire at 605 cps. (C) Data from 0.001-in. wire at 2.28 kc/sec.

²² K. R. Atkins, *Liquid Helium* (Cambridge University Press, London, 1959), p. 148.

²³ G. J. C. Bots and C. J. Gorter, *Physica* **26**, 339 (1960).

The wire radius and penetration depth are at least two orders of magnitude less than the radial distance from the wire to the nearest obstacle. In this respect, the wire is expected to behave as if it were in an infinite volume of fluid, no corrections being needed for the proximity of the boundaries. To our knowledge, no solution to the hydrodynamic equations exists for the case of a wire vibrating in a concentric cylinder.^{23a} Stokes¹⁹ has given a solution for the similar problem of a sphere undergoing small transverse oscillations in a spherical cavity however, which shows that the correction in $k'(m)$ due to the presence of the walls is proportional to the cube of the ratio of the radius of the sphere to the radius of the cavity. Although the equivalent problem for the cylinder has not been solved, one might expect, by symmetry arguments, a correction in $k'(m)$ of the order of the square of the ratio of the wire and

TABLE I. Smoothed data and normal fluid densities at regular temperature intervals.

T (°K)	η (μ P)	ρ_n (g/cc)
2.18	26.0	0.1450
2.16	23.6	0.1300
2.14	21.7	0.1200
2.12	19.9	0.1100
2.10	18.6	0.1055
2.08	17.6	0.0995
2.06	16.8	0.0945
2.04	16.1	0.0898
2.02	15.5	0.0855
2.00	14.9	0.0807
1.98	14.5	0.0778
1.96	14.2	0.0740
1.94	13.8	0.0702
1.92	13.6	0.0678
1.90	13.4	0.0624
1.88	13.2	0.0600
1.86	13.1	0.0568
1.84	13.0	0.0536
1.82	13.0	0.0504
1.80	13.0	0.0472
1.75	13.0	0.0400
1.70	13.0	0.0346
1.65	13.1	0.0289
1.60	13.2	0.02465
1.55	13.3	0.0205
1.50	13.5	0.0165
1.45	13.8	0.0136
1.40	14.1	0.01079
1.38	14.3	0.01000
1.36	14.5	0.00920
1.34	14.7	0.00840
1.32	14.9	0.00765
1.30	15.2	0.00686
1.28	15.4	0.00628
1.26	15.9	0.00568
1.24	16.3	0.00510
1.22	16.9	0.00458
1.20	17.5	0.00405
1.18	18.3	0.00360
1.16	19.3	0.00318
1.14	20.6	0.00280
1.12	22.7	0.00243
1.10	26.8	0.00212

^{23a} Note added in proof. We are indebted to R. G. Hussey for pointing out the existence of such a calculation [L. A. Segel, Quart. Appl. Math. 8, 335 (1961)]. This calculation is in agreement with our estimate below.

TABLE II. Deviation of apparent viscosity η from smoothed value η_s for different values of m .

m	a (inches)	f (kc/sec)	T (°K)	$(\eta - \eta_s / \eta_s)\%$
2.89	0.003	1.97	1.22	-1.2
2.86	0.003	1.97	1.22	+1.2
2.85	0.003	1.97	1.22	+1.8
1.425	0.001	2.61	1.245	+2.5
1.20	0.001	1.79	1.245	-1.2
0.810	0.001	0.850	1.245	+2.5
0.783	0.001	3.34	1.128	+5.5
0.720	0.001	2.84	1.128	+6.0
0.643	0.001	2.18	1.128	+1.8
0.573	0.001	0.453	1.245	-4.9
0.517	0.001	1.065	1.126	-3.7
0.495	0.001	0.795	1.126	-4.1
0.385	0.001	0.545	1.126	+8.7
0.285	0.001	0.293	1.126	+28.5

enclosure radii. This is always less than 10^{-5} in the present application, and has therefore been ignored. That this correction is indeed negligible is shown by the observation that a factor of three in wire size, which should give almost an order of magnitude change in the correction, made no noticeable effect on the viscosity.

The temperature and decay constant measurements are sources of random error. The initial deflection of the wire is only approximately sinusoidal and thus contains a small percentage of higher harmonics in addition to the fundamental mode. These harmonics are of a low amplitude and decay rapidly, however. The decay times are measured directly from photographs of oscilloscope traces. At least 15 amplitudes are measured over approximately one decade of amplitude. The amplitudes are plotted on sem-log paper and a straight line visually fitted to them. Effects of higher harmonics or modulation of the exponential would cause such a plot to deviate from linearity, and these data are discarded. Several determinations of scatter in decay times were made by taking a number of photographs under identical conditions. The resultant scatter was always less than 2%. At low values of m , such as are obtained at the lowest temperatures, this can result in scatter in the viscosity up to 5%.

The manometers can be read to approximately 0.2 mm of oil, and the electronic regulator can stabilize the temperature to better than that precision. This gives temperature uncertainties on the order of 0.2 millidegrees near the lambda point, and 2.0 mdeg near 1.2°K. At low temperatures and small values of m this implies uncertainties in the normal fluid densities which give maximum errors of 2% in the viscosity. Effects of temperature drift during a measurement are very small since the measurement itself takes only a few seconds. Some scatter is also introduced by reading the graph of $k'(m)$. This could contribute a maximum error of 3% to the viscosity at the smallest values of m .

The theory from which the viscosities are calculated is subject to the condition of Eq. (3); i.e., that the penetration depth not be large compared to the wire

radius. In order to determine how the calculated viscosity depends on the value of m , a series of measurements were carried out in the region of 1.2°K at different frequencies and with different wire radii. In Table II are shown the deviations of the apparent viscosities from the smoothed values for values of m from 2.89 down to 0.285. The results show no trend down to $m=0.495$ but are systematically higher for values of m smaller than this. Since the smallest value of m used in establishing final smoothed values was 0.643, it is clear that no significant systematic error can be attributed to this effect.

Two approximations were used to simplify the calculations. We have used the expression for $k'(m)$ given in Eq. (5) when m is greater than 2.9. In only two of the six runs was this approximation used. The error introduced was less than $\frac{1}{2}\%$ in this case. For values of m smaller than 2.9 a large graph of the function $k'(m)$ plotted from the table given by Stokes was used.

We have also assumed that the added hydrodynamic mass of the wire, μ' , can be neglected with respect to μ . If we write the mass-per-unit length of the wire in terms of its density as

$$\mu = \pi \rho a^2, \quad (8)$$

then using Eq. (4) we have

$$\mu'/\mu = k(m)\rho_n/\rho. \quad (9)$$

If we restrict the value of m to greater than 0.5 as explained above, then $k(m)$ is less than 4.0 as can be seen from Fig. 1, and the ratio in Eq. (9) becomes significant only at high temperatures and densities. Thus, the 0.001-in. wire data is approximately 1% low at 2.16°K and 0.5% low at 2.00°K. The correction to the 0.003-in. wire is less than half that of the smaller one.

IV. DISCUSSION

The viscosity is shown as a function of temperature in Fig. 5, in which we compare our results to those

obtained with a rotating cylinder viscometer by Woods and Hallett¹⁶ and Heikkila and Hallett.¹⁵ The agreement between our data and the most recent rotating cylinder results is excellent. It should be noted that several investigators have claimed agreement with Heikkila and Hallett if their point at 1.13°K is considered low. Woods and Hallett suggest, however, that the points between 1.2 and 1.4°K should rather be taken as being high.¹⁶ Our results support this contention.

The agreement between the vibrating wire and rotating cylinder measurements is the only example of close correspondence between reported viscosity measurements below 1.6°K. The rotating cylinder is a steady-state device of relatively large physical dimensions, while the present apparatus is oscillatory and relatively small. The rotating cylinder measurements do not depend on the normal fluid density. Neither measuring technique requires any calibration or normalization.

For the temperature range from 1.8°K to the lambda point it was found that the decay time, τ , for a given wire radius and frequency, varied linearly with the temperature, and could be given to better than 1% by an expression of the form

$$\tau = \tau_0(1 - T/T_0). \quad (10)$$

These data are given in Fig. 6. The intercept T_0 was $2.47 \pm 0.01^\circ\text{K}$ for all three of the wires measured in this temperature range; τ_0 varied approximately as $a\omega^{-1/2}$ the values for curves A, B, and C of Fig. 6 being 1.12, 0.745, and 0.395 sec, respectively. No physical explanation is evident for this interesting behavior.

ACKNOWLEDGMENTS

This work has been partially supported by a grant from The Boeing Company, and by the U. S. Air Force Office of Scientific Research, Grant number AF-AFOSR 62-298.

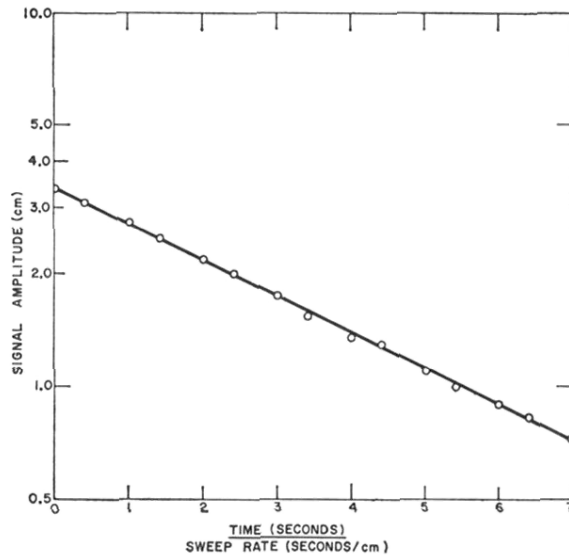
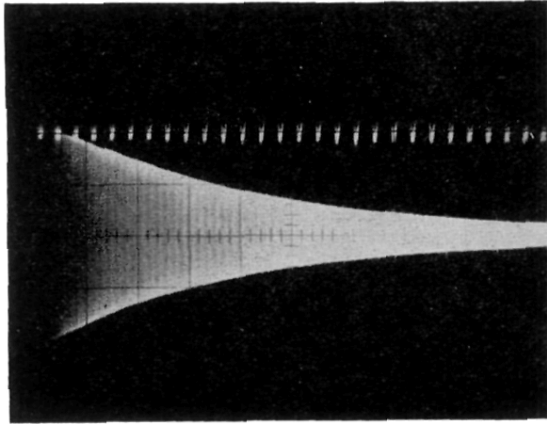

FIG. 2. (a) A typical oscilloscope photograph showing the exponential decay of the wire and the frequency. (b) The amplitudes of the exponential decay photograph [Fig. 2(a)] on a semilog plot.